



spencer interiors
Vancouver BC Canada
> tel: 604 736-1378
> fax: 604 736-1338
> www.spencerinteriors.ca



fresh modern living

CHARACTERISTICS *

Both the "shaped sides" with varying thickness (2 to 4 cm), the shelves and the drawers are available in wood veneered particle board panels (vertical grain) or in particle board covered with a synthetic varnish (for the lacquered version).
 The Unless bookcase is composed of horizontal modules that are shipped assembled (including the hardware to connect the modules).
 The base elements are equipped with adjustable feet.

NO MADE TO MEASURE SOLUTION AVAILABLE.

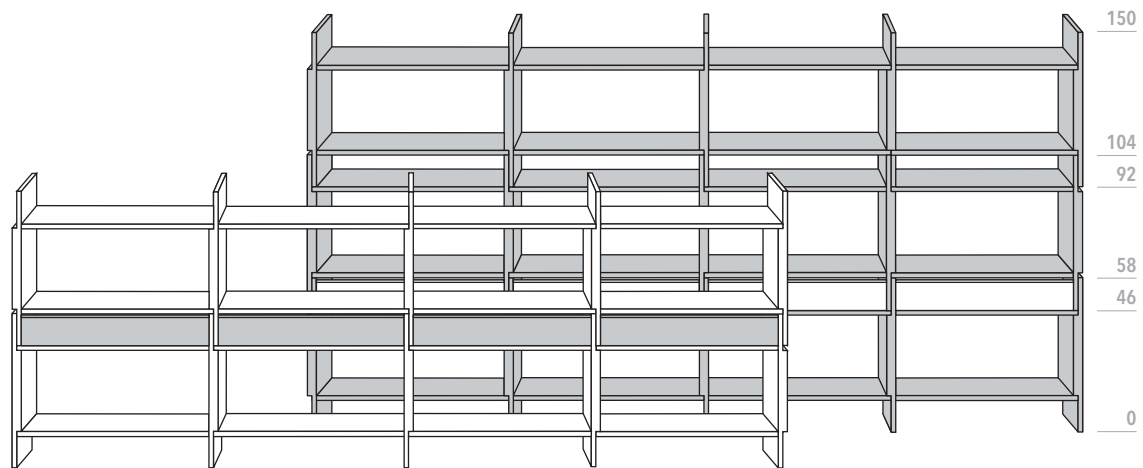
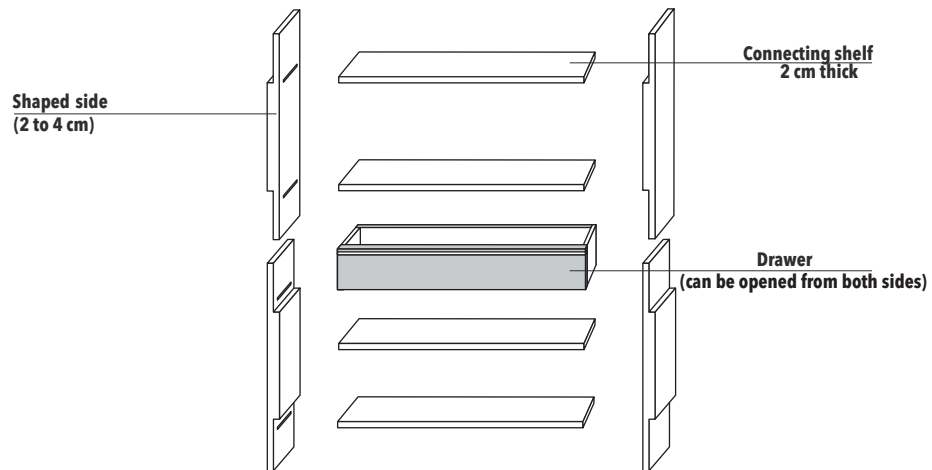



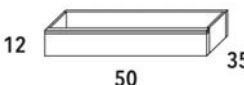





UNLESS



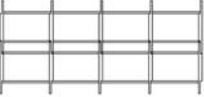

DRAWER THAT CAN BE OPENED FROM BOTH SIDES	width			DARK OAK FRONT	HI GLOSS WHITE FRONT
	50		3UN10		

*In compliance with article no. 120 -April 10th 1991 ("consumer information") and with decree no. 101 ("applicable regulations") February 6th 1997.

UNLESS

width	H 58 D 35 MODULES	MATT LACQ WHITE	DARK OAK	width	COMPOSITIONS * H104 D 35	MATT LACQ WHITE	DARK OAK
58.8	 <p>3UN01 mc 0,145</p>			58.8	 <p>UN012 mc 0,290</p>		
113.6	 <p>3UN02 mc 0,275</p>			113.6	 <p>UN022 mc 0,550</p>		
168.4	 <p>3UN03 mc 0,400</p>			168.4	 <p>UN032 mc 0,800</p>		
223.2	 <p>3UN04 mc 0,530</p>			223.2	 <p>UN042 mc 1,055</p>		
278	 <p>3UN05 mc 0,070</p>			278	 <p>UN052 mc 0,130</p>		

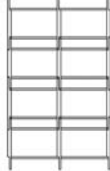
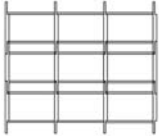
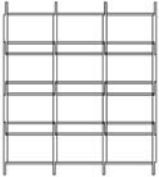
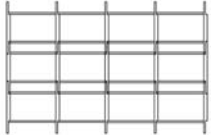
UNLESS

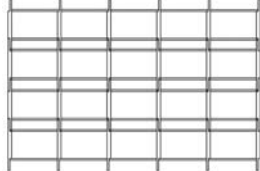
width	COMPOSITIONS * H 150 D 35	MATT LACQ WHITE	DARK OAK	width	COMPOSITIONS * H 196 D 35	MATT LACQ WHITE	DARK OAK
58.8	 <p>UN013 mc 0,430</p>			58.8	 <p>UN014 mc 0,575</p>		
113.6	 <p>UN023 mc 0,820</p>			113.6	 <p>UN024 mc 1,095</p>		
168.4	 <p>UN033 mc 1,200</p>			168.4	 <p>UN034 mc 1,600</p>		
223.2	 <p>UN043 mc 1,580</p>			223.2	 <p>UN044 mc 2,105</p>		
278	 <p>UN053 mc 0,200</p>			278	 <p>UN054 mc 0,260</p>		

* Add drawers only for 12 cm h spaces.