



LOFT ADRIANO PIAZZESI

Modello depositato - Registered model

È un sistema di sedute estremamente innovativo in grado di assecondare specifiche esigenze di comfort grazie a due meccanismi brevettati di facile utilizzo.

La possibilità di far scorrere all'indietro il blocco bracciolo e schienale modifica l'ampiezza della seduta e permette di avere sullo stesso divano due profondità diverse: 75 cm per un uso tradizionale ed una postura più composta oppure 120 cm che trasformano il Loft in una vera e propria chaise-longue.

Per la sola versione divano è disponibile il doppio movimento che consente di ottenere contemporaneamente le due profondità di seduta.

Un altro meccanismo consente di ruotare lo schienale portandolo, attraverso una serie di posizioni intermedie, da una posizione orizzontale, un vero e proprio piano d'appoggio, ad una posizione verticale di maggiore comfort e sostegno per la schiena.

Sono disponibili divani di varie dimensioni e una versione componibile con elementi terminali, chaise-longue e pouf d'angolo che permettono di creare soluzioni e composizioni angolari molto scenografiche. L'innovazione dei meccanismi fa di questo sistema di sedute una vera e propria piattaforma polifunzionale dove vivere il relax assoluto in ogni sua declinazione.

Il design "minimal" e razionale è arricchito da cuscini schienale morbidi e leggeri, facilmente spostabili a seconda delle esigenze.

By means of a simple movement, the mechanism allows to modify the depth of the seating area: this is the original feature of this sofa system, an innovative invention which offers a superior degree of comfort and enables the entire sofa concept to be experienced in an extremely personal manner.

The mechanism, easy to be used, permits two different seat depths: 75 cm for a traditional use and a more upright posture, 120 cm to obtain a chaise-longue. The sofa can be also supplied with split independently-adjustable back, which permits two different seat depths at the same time.

Another mechanism permits to adjust the back from horizontal to vertical, through a number of middle positions.

The programme consists of sofas of different dimensions, lateral units, chaise-longues and corner poufs which can be combined in several ways to create personal arrangements.

In this way Loft becomes more than a sofa, it turns into a real open space, a multipurpose platform for relaxation.

The "minimal" and rational design is enriched by soft back cushions, very easy to be moved, to satisfy every request.

**spencer
interiors**

spencer interiors
vancouver bc canada
telephone: 604.736.1378
www.spencerinteriors.ca

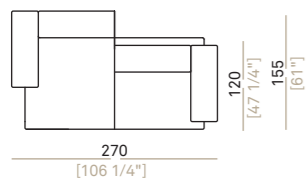

Divani **LOFT** (info p. 174) con doppio movimento, versione capitonné in Pelle A/2402. Cuscino schienale in Pelle A/2402. Tavolino **LOFT** (info p. 195). Poltrona **LOVE** (info p. 191) in tessuto collezione Velvet E/5146. Tavolino **RING** (info p. 197).

Sofas **LOFT** (info page 174) with split independently-adjustable back in leather A/2402, quilted seat. Cushion in leather A/2402. Side table **LOFT** (info page 195). Armchair **LOVE** (info page 191) in fabric E/5146 collection Velvet. Low table **RING** (info page 197).



Divano **LOFT** (info p. 174) con doppio movimento, versione capitonnè in Pelle A/2402. Cuscino schienale in Pelle A/2402. Tavolino **RING** (info p.197).

Sofa **LOFT** (info page 174) with split independently-adjustable back in leather A/2402, quilted seat. Cushion in leather A/2402. Low table **RING** (info page 197).

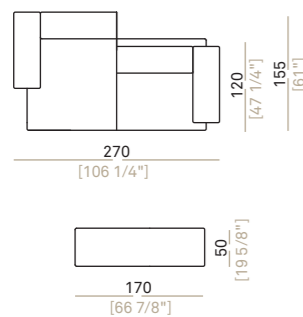

Divano **LOFT** (info p. 174) con doppio movimento in tessuto collezione Maira D/4650. Cuscini schienale in tessuto collezione Velvet E/5142 e cuscinetti bracciolo in tessuto collezione Shabby D/4620. Pouf **LOFT** (info p. 174) in tessuto collezione Velvet E/5142. Pouf **CUBO** (info p. 188) in tessuto collezione Shabby D/4620. Tavolino **LOFT** (info p. 195). Poltrona **MOON** (info p. 192) in tessuto collezione Maira D/4650. Tappeto **MAREA** (info p. 200) colore melanzana.

Sofa **LOFT** (info page 174) with split independently-adjustable back in fabric D/4650 collection Maira. Large cushions in fabric E/5142 collection Velvet and small cushions in fabric D/4620 collection Shabby. Ottoman **LOFT** (info page 174) in fabric E/5142 collection Velvet. Pouf **CUBO** (info page 188) in fabric D/4620 collection Shabby. Side table **LOFT** (info page 195). Armchair **MOON** (info page 192) in fabric D/4650 collection Maira. Rug **MAREA** (info page 200) aubergine.

Composizione "A" LOFT (info p. 174) in tessuto collezione Riga E/5246. Cuscini schienale in tessuto collezione Riga E/5245 e collezione Velvet E/5138. Tavolino LOFT (info p. 195).

Composition "A" LOFT (info page 174) in fabric E/5246 collection Riga. Cushions in E/5245 collection Riga and E/5138 collection Velvet. Side table LOFT (info page 195).



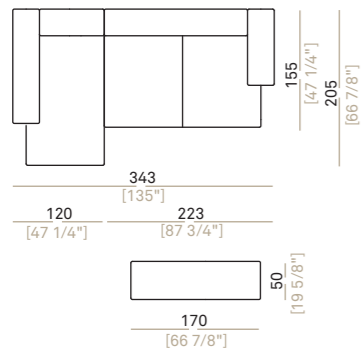

Composizione "A" LOFT (info p. 174) in tessuto collezione Riga E/5246. Cuscini schienale in tessuto collezione Riga E/5245 e Riga E/5247. Pouf LOFT (info p. 174) in tessuto collezione Riga E/5246. Tavolino LOFT (info p. 195). Poltrona FLY (info p. 190) in Pelle A/2206. Tappeto STRIPE (info p. 201) colore grigio ghiaccio.

Composizione "A" LOFT (info page 174) in fabric E/5246 collection Riga. Back cushions in E/5245 and E/5247 collection Riga. Ottoman LOFT (info page 174) in fabric E/5246 collection Riga. Side table LOFT (info page 195). Armchair FLY (info page 190) in leather A/2206. Rug STRIPE (info page 201) ice grey.



Composizione "A" LOFT (info p. 174) in tessuto collezione Riga E/5246. Cuscini schienale in tessuto collezione Riga E/5245 e Riga E/5247. Tavolino LOFT (info p. 195).

Composition "A" LOFT (info page 174) in fabric E/5246 collection Riga. Back cushions in E/5245 and E/5247 collection Riga. Side table LOFT (info page 195).

LOFT

Modello depositato - Registered model

ADRIANO PIAZZESI, 2003

(p. 62)



Struttura: ferro verniciato

Imbottitura seduta: poliuretano indeformabile (D35+D35 soft con inserti D70), fodera in tomana

Imbottitura bracciolo e schienale: poliuretano indeformabile (D40), fodera in accoppiato 6 mm.

Spalliera: cotone riempitura fiocco piuma

Piano di molleggio: legno multistrato

Altezza seduta: 36 cm

Altezza bracciolo: 54 cm

Piedi: acciaio inox (h. 10 cm)

ATTENZIONE:

Gli elementi componibili non si possono realizzare a solo. La versione "capitoné" è disponibile solo in pelle ed ecopelle e non è sfoderabile. Su richiesta gli elementi possono essere inviati smontati.

Structure: varnished iron

Seat Padding: non-deformable polyurethane (D35 and D35 Soft with frame D70), protected by synthetic fibre

Arm and back Padding: non-deformable polyurethane (D40) protected by coupled 6 mm synthetic lining

Cushions Padding: cotton cover filled with mixed down

Springing: plywood

Seat Height: 36 cm

Arm Height: 54 cm

Feet: inox steel (h. 10 cm)

ATTENTION:

the sectional units cannot be supplied as single elements. The version "capitoné" (quilted seat cushions) is available only in leather and imitation leather and in this case the covers are not removable. On request the units can be shipped disassembled.

Piedi / Feet

acciaio inox
stainless steel

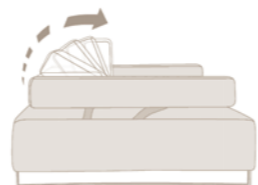
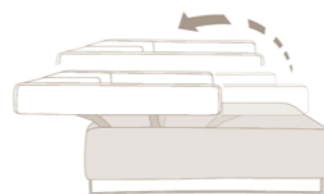

Divano Sofa

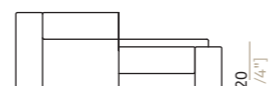
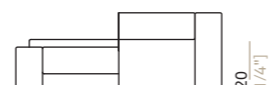
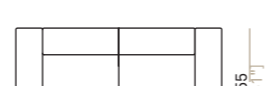
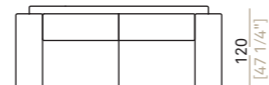
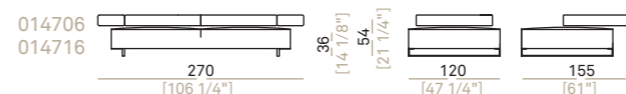
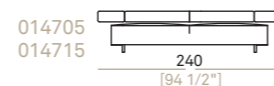
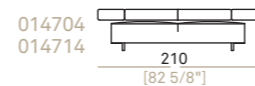

Poltrona Armchair

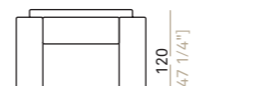

Pouf angolare Corner pouf

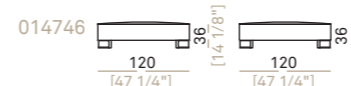

Pouf Pouf

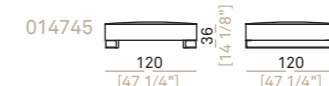

Elemento laterale dx o sx Right or left unit

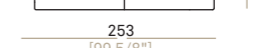
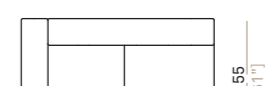
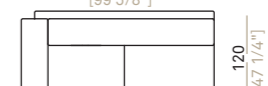
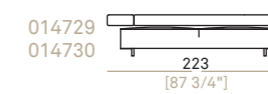
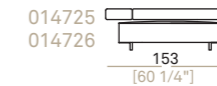

Chaise longue dx o sx Chaise longue with right or left arm

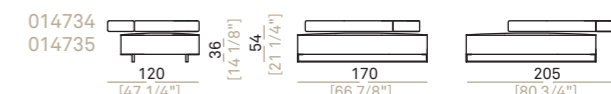

Pouf Pouf

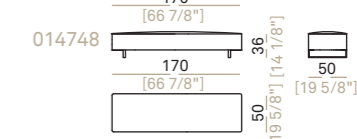

spencer
interiors

spencer interiors
vancouver bc canada
telephone: 604.736.1378
www.spencerinteriors.ca